



Owner's Manual

Model Elite

WARNING: Improper installation, adjustment, alteration, service or maintenance can cause injury and property damage. Refer to this manual. For assistance or additional information consult a qualified installer, service agency or the gas supplier.

Save This Manual!

FOR YOUR SAFETY IF YOU SMELL GAS

- Open Windows
- Do not touch electrical switches
- Extinguish any open flames
- Immediately turn off gas supply and call your gas supplier

FOR YOUR SAFETY

- Do not store or use gasoline or other flammable liquids in the vicinity of this or any other appliance.



The installation of the appliance must conform with local codes or, in the absence of local codes, follow National Fuel Gas Code, ANSI Z233.1 /NFPA 54,(USA) the Natural Gas and Propane Installation Code,CSA B149.1 (Canada)





Notice To Customer

This Sheet May Be Removed By Refrigerator Owner ONLY
Read these instructions before lighting the burner, and follow them
to their entirety.

The installation of the appliance must conform with local codes or, in the absence of local codes, follow National Fuel Gas Code, ANSI Z233.1 /NFPA 54,(USA) the Natural Gas and Propane Installation Code,CSA B149.1 (Canada)

1. This appliance must be installed by a licensed installer.
2. Your gas pressure should not exceed 12" Water Column or be lower than 11" Water Column. Have your local propane supplier check this for you.
3. Be sure your ventilation and clearances from combustibles are according to the Owner's Manual. See Owner's Manual for instructions.
4. Make sure your refrigerator is level. See Owner's Manual for instructions.
5. You must install the heatshield. This is a CSA requirement. See Owner's Manual for installation instructions.
6. For technical support consult the Owner's Manual, Diamond DVD, contact your local dealer, or call 231-734-2500.



Certified and Manufactured by

Diamond Refrigerators

No Electricity? No Problem!

© Diamond Refrigerators 2012-2013 ALL RIGHTS RESERVED. This material is protected under International and Federal Copyright laws and treaties. Any unauthorized reprint or use of this material is prohibited. No part of this material may be reproduced or transmitted in any form or by any means, electronic or mechanical, including photocopying, recording, or by any information storage or retrieval system without written permission from Diamond Refrigerators.

Cover Photo by Amy Urick 2012

Version 5.0

Thank-you for purchasing a Diamond refrigerator. We hope you enjoy your refrigerator as much as we did manufacturing it. We designed this refrigerator especially with you, our customer, in mind. We hope you will consider Diamond for future purchases.

This Owner's Manual does not cover every possible situation that might occur. We assume some prior experience with propane products and common sense. We want to assure you that this refrigerator should give you years of trouble free service. If for some reason this refrigerator causes problems, we will stand behind you with a 5 year limited warranty. Thoroughly read the Owner's Manual, and follow all instructions. If you have questions regarding the use and operation of your refrigerator, please contact your local dealer or call 231-734-2500.

To install this product you must have:

- Level
- 13/16" (21 MM) fixed wrench or adjustable wrench
- Philips #2 Screw Driver

After installing, make sure:

- Door handles are secure and tight (some models only)
- Door seals are sealing properly
- Heat shield is installed
- Front grille is securely attached (some models only)
- Refrigerator is level and solid on all corners
- Mail pre-addressed Warranty Card

Proper Disposal of your old Refrigerator or Freezer

Risk of child entrapment

Child entrapment and suffocation are not problems of the past. Junked or abandoned refrigerators or freezers are still dangerous- even if they will sit for "just a few days". If you are getting rid of your old refrigerator or freezer, please follow the instructions below to help prevent accidents.

Proper Disposal of Refrigerators/Freezers

We strongly encourage responsible appliance recycling/disposal methods. Check with your utility company or visit www.recyclemyoldfridge.com for

more information on recycling your old refrigerator.

Before you throw away your old Refrigerator/
Freezer:

- Remove Doors
- Leave Shelves in place so children may not easily climb inside.
- Have refrigerant removed by a qualified technician.

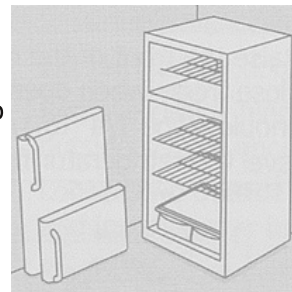

Table of Contents

	Page
Cooling Unit Diagram.....	22
General Operation.....	9
Adjusting Temperatures.....	9
Operating Tips.....	9
Freezing Tips.....	9
Lighting.....	8
Hand Lighting.....	9
Shut-down Procedure.....	9
Maintenance.....	9
Cleaning the Refrigerator.....	9-10
Defrosting the Refrigerator.....	10
Cleaning the Burner.....	10
Cleaning the Flue and Baffle.....	11
Cleaning the Orifice.....	11
Gas Related Spare Parts.....	11
Gas Train Assembly Diagram.....	14-15
Refrigerator Interior Replacement Parts.....	16-19
Refrigerator Setup.....	6
Unpackaging Your Refrigerator.....	6
Ventilation.....	6-7
Clearances from Combustibles.....	7
Heat Shield Installation.....	7
Gas connection.....	7
Leak testing.....	8
Gas Pressure.....	8
Interior Light.....	8
Leveling.....	8
Lighting.....	8
Reversing the door swing.....	20
Handle Installation.....	21
Transporting Refrigerator.....	11
Troubleshooting.....	12-13
Warranty.....	11

Unpackaging your Refrigerator

To unpack your refrigerator cut and remove all plastic strapping; remove cardboard box and edge protectors, then remove the plastic bag covering the refrigerator. **Caution, keep plastic bag away from children. Dispose of, or recycle promptly.** Proceed by removing the packaging tape from all Styrofoam and cardboard corners, and remove the refrigerator from its cardboard/ Styrofoam base. Leave tape from the doors in place until refrigerator is in its desired spot. Now transport the unpackaged refrigerator to the site. Note: A padded appliance hand truck is great to move the refrigerator through doors and up or down stairways. A padded appliance hand truck can be rented from most appliance retail shops.

➔ A qualified person should perform all gas connections and installations.

WARNING: Propane is flammable. If you smell gas, extinguish open flames; do not operate electrical switches; open windows and immediately call your gas supplier.

WARNING: This product can produce Carbon Monoxide. Carbon Monoxide has no odor and can kill you. The burner and the flue system must be kept clean. Keep this manual for cleaning instructions.

To set up refrigerator, please follow these instructions.

1. Ventilation

Air ventilation (circulation) is very important. Always provide ample air circulation behind and above the refrigerator. The purpose for proper air circulation is:

- 1.) To prevent any heat build-up resulting from the lack of ventilation.
- 2.) To provide ample airflow for proper refrigerator performance.
- 3.) Allow no less than 11.5" (29.2 CM) from the top of the refrigerator to the ceiling or other obstructions. To create air circulation for better flow, see the following tips.
 - A 6"x24" (15.24 x 60.96 CM) or equivalent hole cut in the floor or back wall with a register installed. When putting the hole in the back wall put the bottom of the hole 6" (15.24 CM) from the floor. Allowing air intake from the basement or crawl space will allow air to circulate up the back of the cooling unit. It is advisable to use a register that can be opened and closed. When possible, cut another 6"x24" (15.24 x 60.96 CM) or equivalent hole towards the top of the back wall to release the heat from the refrigerator to an outside area.
 - Allow 11.5" (29.2 CM) ventilation on the top, 3" (7.62 CM) on the side, and 2" (5.08 CM) from the back of the refrigerator to the wall for additional air circulation. It is recommended that the refrigerator is installed free standing. See the illustration on the bottom of this page for more information.
 - Venting the flue pipe directly outside or into an attic or similar plumbing as a water heater requires, will rid the area of most of the heat the refrigerator produces. Do not make a sealed connection between the flue and vent pipe connection. Simply hover the vent pipe over the flue pipe allowing some air to draft in at this point to create a good airflow.

- If the circulation is suspected to be inadequate, roll refrigerator away from the walls and other obstructions and let it run in this position for a period of time and compare performance to the intended location. If the refrigerator compartment lowers drastically during this period while under similar circumstances of use, the air circulation in the intended location is inadequate.

Minimum Clearances from Combustibles

Top 11.5" (29.2 CM)

Sides 3" (7.62 CM)

Back 2" (5.08 CM)

Do NOT install this appliance directly on carpeting. Prior to installation, carpeting must be removed, or protected by a wood or metal panel beneath the refrigerator which extends at least the full width and depth of the refrigerator. Failure to do so increases the risk of fire.

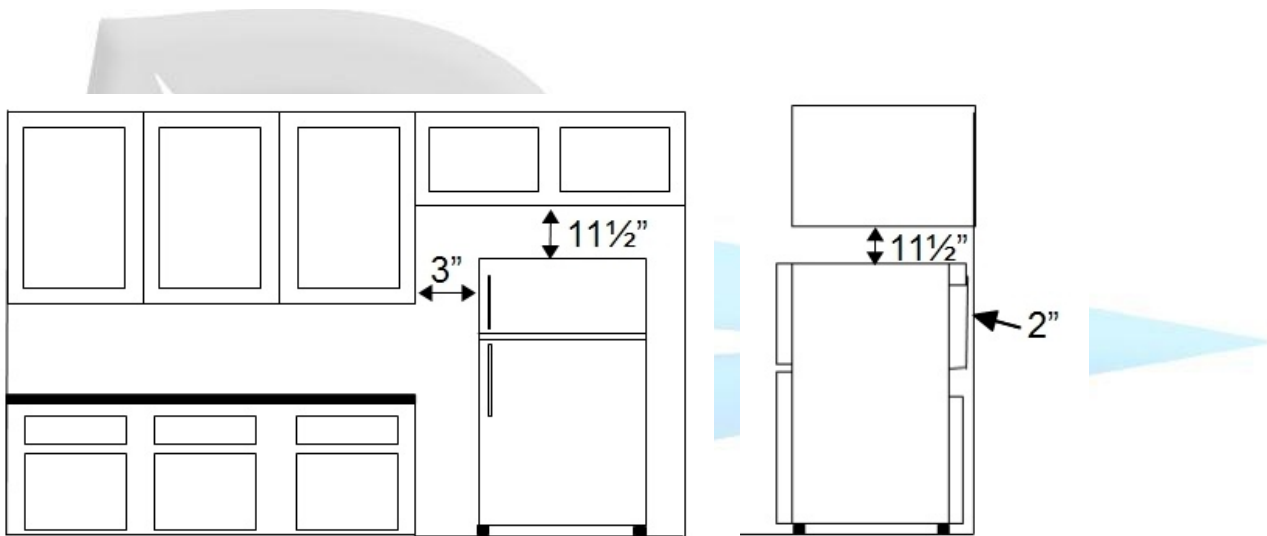

2. Heat Shield Installation

The heat shield must be installed before lighting the refrigerator and must not be removed while under operation. This is a CSA requirement. The heat shield and the screws for installation are included with the refrigerator. The heat shield must be fastened to right side of the refrigerator.

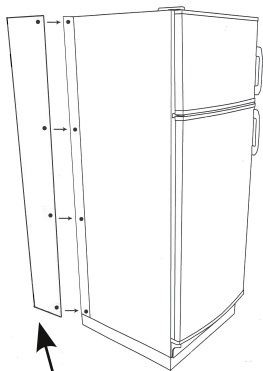

Heat Shield

3. Gas Connection.

All Diamond refrigerators are equipped with a 3/8" SAE (UNF 5/8" - 18) male flare hookup. This connection is located on the back of the refrigerator towards the bottom, left side. This fitting does not require the use of any paste, tape, or liquid sealers. Use a flex line to connect the refrigerator from the gas source that is long enough to move the refrigerator away from the wall to access the rear for service. When using a flex line, it must comply with local codes and in Canada with the provision of the current standard CAN 1-6.10, Metal Connectors for Gas Appliances. Be careful not to over tighten the connection. If local regulations require a rigid gas supply connector, the refrigerator should be placed where there is sufficient space in

the back for servicing. The fitting needs only to be snug with a wrench. It is recommended that you install an ON/OFF gas valve before the flex line.

4. Leak Testing

Prior to lighting your refrigerator, you must check for leaks. This is done by mixing some dish soap with water and applying the solution to all gas fittings with a toothbrush or paintbrush then turn on your gas supply. If leaks are present, air bubbles will appear. Should you find air bubbles, shut off gas supply and re-tighten fitting. Be careful not to over tighten the fitting. **NEVER use a flame to check for leaks!** If a leak is found, do not light the refrigerator for 10 minutes to allow the gas to dissipate from the burner area.



Leak Present!

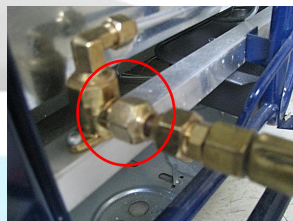

No Leak

5. Gas Pressure

Diamond propane refrigerators are designed to operate from an LP gas supply with a gas pressure of 11" water column. Have your gas supplier or another qualified person check this for you. The gas pressure can be tested at the test port on the control panel. (see Picture on the opposite side of this page)

Make sure that the refrigerator and any other appliances on your line are turned on when you check the gas pressure. The refrigerator and its individual shut-off valve must be disconnected from the gas piping system during any pressure testing of that system at or in excess of 1/2" psig.

6. Interior Light

Diamond refrigerators are equipped with LED interior lights. Light may or may not be used. If you wish to use the light, insert four AA (included) into the battery holder on the back of the refrigerator.

7. Leveling

Diamond refrigerators operate with the use of gravity. The flow rate of the liquids is determined by the angle of the tubing in the cooling unit. It is critical

that the refrigerator is level to get the correct flow for the best efficiency. To level the unit, place a level

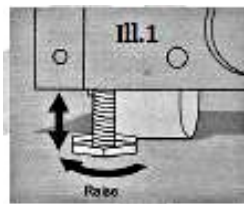

Illustration 1

on the top of the refrigerator and level the refrigerator from right to left and front to back. Turn the leveling feet clockwise to raise the refrigerator. (See ill. 1)

If the floor under the refrigerator is out of level, it may be needful to put shims under the leveling feet.

Lighting

After the setup of the refrigerator is complete, you are ready to light the burner. Lighting the refrigerator for the first time will take longer than usual due to the air in the gas lines.

We recommend that upon initial lighting, that you take a picture or a good look of the flame for future reference of size and color. Check the flame size and color every six (6) months or after every ignition.

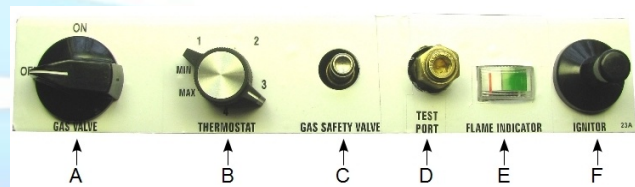

- 1.) Remove the front grill (some models only)
- 2.) Turn the Thermostat Knob (B) to position 3
- 3.) Turn ON/ OFF valve (A) to "ON" position (vertical).
- 4.) Press in and hold the gas safety button (C) while pushing the ignitor button (F) repeatedly to light the burner. Watch the red needle on the flame indicator (E) to see if the flame is lit. When lit, the red needle will move from white to green. This procedure may need to be repeated several times if the refrigerator is being lit for the first time, or has not been lit for a period of time due to air in the gas line.



Remove the front grill

Hand Lighting

If for some reason the refrigerator will not light with the peizo ignition or the ignitor fails to spark, it is possible to hand light the burner. To do this you will need two people and simply use the above procedure and replace the ignitor button with a person at the burner with a lighter.

Shut Down Procedure

- Turn the ON/Off valve (A) to "OFF" postion (horizontal)
- Turn off the gas supply.
- If the refrigerator will not be used for a period of several weeks, we recommend defrosting, cleaning the refrigerator and leaving the doors slightly open.

General Operation

Adjusting Temperatures

Diamond refrigerators are equipped with a thermostat that can be adjusted. To do this, turn the thermostat knob to the desired setting. Always start the refrigerator at setting "3" and let the unit cool down for at least 8-12 hours. Then place food in the refrigerator in small amounts spread out every couple of hours. If a large portion of room temperature food is placed into the refrigerator at one time, this will overload the cooling system and it may take three times longer to recover. Once you have placed the food into the refrigerator, allow the unit to stabilize at least overnight. Adjust the thermostat to a higher number if a colder temperature is desired. **Warning: the colder you turn your refrigerator, the faster frost will build up on the fins.** Adjusting to the correct temperatures may take a span of a few days. Once this is achieved, then adjusting should only need to be done if the ambient temperatures (between seasons) change, or your lifestyle changes (more people using the refrigerator).

Operating Tips

All propane refrigerators are manual defrost. If the frost build-up is solid between the fins in the refrigerator, it is time to defrost. (See defrosting page 10)

Follow the tips below to keep frost levels lower.

- Check the door seals for leaks.
- Place lids on food and liquid containers before placing them in the refrigerator.
- Adjust the thermostat knob to keep food at the desired temperature. This will generally be between settings 2 and 3. Turning the control higher, or to "MAX" will not necessarily make your fridge colder, especially if the temperature probe is encased in ice on the fins.
- Let food cool to room temperature or colder prior to storage in refrigerator.
- Wipe condensation off cold containers with a dry towel prior to placing them into the refrigerator.
- Limit how often the door is opened, especially in hot humid weather.

Freezing Tips

For items with higher levels of sugar, such as ice cream, put these items on the bottom plate of the freezer. This is always the coldest spot in the freezer. Chill warm items before placing them into the freezer. When putting water in the freezer for freezing, make sure your water is as cold as possible and put these containers on the freezer shelf with meat and vegetables. It is advisable to use metal ice trays, because metal transfers cold better than plastic. When quick-freezing items such as water and juice, these items should be placed as far back and towards the bottom as possible.

Maintenance

Cleaning the Refrigerator

Proper cleanliness of your refrigerator is important, especially the inside. A recommended and convenient time is during regular maintenance or right after defrosting. Cleaning both the inside and outside should be done with a soft cloth and mild soap and warm water solution. Do not use a harsh cleaner or a coarse cloth. **Do not remove any labels!**

Cleaning the outside of your refrigerator requires a soft cloth and mild soap, warm water solution. Check the door seals for debris, for this can produce an unsealed surface and cold air can escape. Keeping the

seals clean is especially critical to assure longer life and proper sealing, especially in the lower parts of the door. When done cleaning, you can wax the refrigerator to prevent from minor scuffs and scratches and improve the overall appearance of your refrigerator. A standard auto wax works great. Do not wax the handles, plastic, or the rubber gasket. Cleaning the cooling unit will improve the overall efficiency. This should be done every three months. Simply use a large bristle brush and remove the lint and dust from the condenser fins and the absorber coils.

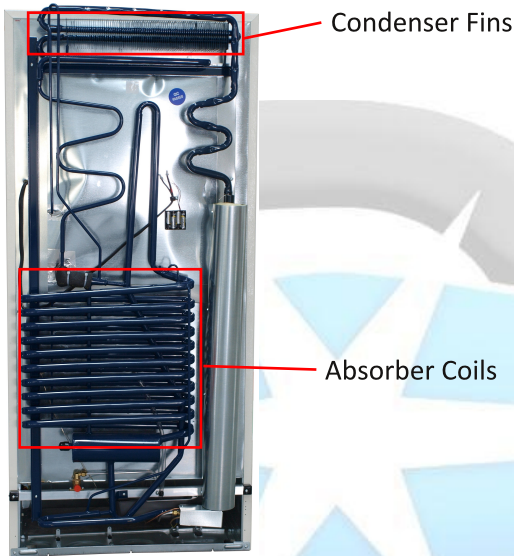

Keep the area around and under the refrigerator clean. If this is not done, dust and other light debris will be sucked into the burner tube. This is a common problem with refrigerator failure. This should be done every three months or more often is better. (See Cleaning the Burner, Cleaning the Flue and Baffle, and Cleaning the Orifice section for more information)

Defrosting

There are two ways to defrost your refrigerator: 1.) Turn the thermostat knob to setting "MIN" overnight. The next morning, turn the knob to its original setting. Doing this weekly should be sufficient to keep the ice off the fins. **Remember, you must turn thermostat knob to its original setting or the refrigerator will not cool properly!** 2.) Once ice build-up is solid between fins, turn off refrigerator, and allow ice to thaw, and then remove the ice by hand.

You can use a plastic scraper to remove the larger chunks. Do not use an ice pick or metal scraper. The drain pan is not designed to hold the large amount of water this defrosting method produces. Drain the drain pan during this process or sponge away the water.

To defrost the freezer, simply sponge the water out of this section since there is no drain in this section

Cleaning the Burner

The burner tube is easily cleaned with compressed air. Air in a Can is another option that works. **Caution:**

Some Air in a Can is flammable. Be sure burner flame is turned off (see Shutdown Procedure) and that the burner has cooled completely! To clean the

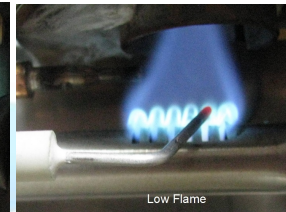
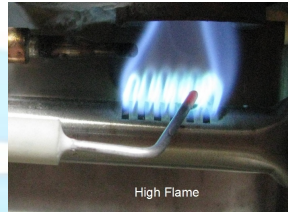

burner, first take the small cleaning brush (included with the refrigerator) and brush out the burner tube to loosen debris. The burner tube does not have any parts in it, so be sure all dirt is dislodged, then take air-in-a-can and blow the dirt out. Once the burner is cleaned, the flame will be crisp and clean. (See high and low flame picture above) If the flame has been burning dirty for any period of time, be sure to clean the flue and baffle. See the Diamond Installation & Maintenance DVD included with the refrigerator for

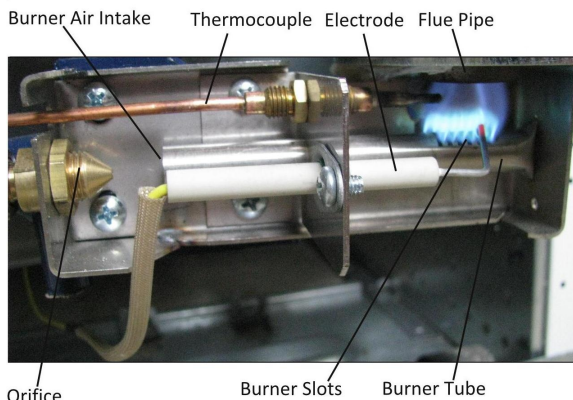

more information and a how-to video explaining this process. The burner should be cleaned every 6 months.

Cleaning the Flue and Baffle

If soot build-up is present inside the flue pipe, or if the flame was burning dirty then cleaning is required. Turn off the gas supply and let the flue pipe cool. Remove the baffle by unhooking the baffle wire from the top of the flue tube and pull up and out. To clean the baffle, take a wire brush and remove the soot. To clean the flue, take the flue baffle and run the baffle up and down at least three times. Be careful not to damage the burner tube. See the Diamond Installation & Maintenance DVD included with the refrigerator for more information and a how-to video explaining this process.

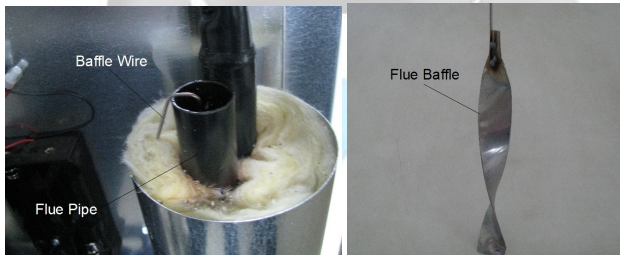

Cleaning the Orifice

It is rare that debris will get around the filters and make it to the orifice. If the flame size is small, the thermostat and gas supply check out good, then it is possible the orifice needs to be cleaned. To remove the orifice, simply take a $\frac{3}{8}$ " (10 MM) wrench and unscrew the orifice.

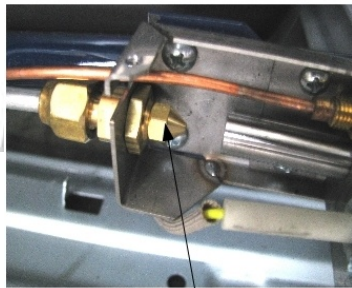

Clean the orifice by washing it in rubbing alcohol or with high-pressure compressed air. **NEVER force ANY object into the orifice! Changing the orifice hole by ANY amount will damage your refrigerator and void your warranty.**

Transporting Refrigerator

Diamond refrigerators can be transported on their side. To transport, lay the refrigerator on the burner

side. (left side facing refrigerator) The refrigerator will not require any additional set-up if transported this way. The refrigerator can also be transported standing, providing the refrigerator is properly strapped.

Warranty

Diamond refrigerators are covered by a five (5) year limited warranty. Five year warranty on the cooling unit. Three year warranty on parts and labor on refrigerator. All warranties are "carry in service". Please see original warranty card supplied within the refrigerator or contact your dealer.

Spare Parts:

Following is a list of spare parts that you can purchase from your local dealer.

- Thermocouple # T-STRD or T-48"
- Orifice # M14
- Baffle # BAFFLE

When purchasing spare parts, please have your model and serial number available. They can both be found on the CSA Rating Plate found on the inside of your refrigerator.

Troubleshooting

Problem	Likely Cause	Solution
Refrigerator and/or Freezer are too warm	Is the burner lit?	If the burner is not lit, re-light and check operation. If the burner does not light, refer to "Burner Will not light"
	Is it time to defrost?	Defrost according to Owner's Manual
	Is the ventilation according to the Owner's Manual?	Make sure ventilation is according to Owner's Manual
	Is the gas pressure correct?	Have a qualified technician check your gas pressure. i.e. your local propane compny. The gas pressure should be 11" W. C.
	Is the ambient temperature extra warm?	Keep door openings to a minimum
	Are the condenser fins dirty?	Clean the condenser fins (See page 10)
	Are the absorber coils dirty?	Clean the absorber coils (See page 10)
	Do you smell ammonia?	If there is an ammonia smell, the cooling system has a leak and must be replaced.
	Check for frost on evaporator outlet tubing	Tip refrigerator forward to 10:00 position and hold it there for 5 seconds, or you can wait for 10-20 hours and the refrigerator will quit by itself. (See note 1)
	Is the refrigerator level?	Level the refrigerator according to the Owner's Manual
Refrigerator compartment freezes my food	Is the burner flame modulating (flame goes "high" to "low" flame while someone else turns the thermostat knob from "Max" to "Minimum")	If the flame does not modulate, the thermostat may be defective. Call your local <i>Diamond</i> dealer for further information and replacement.
	Refrigerator is located in an unheated area, or where the temperature is low	If the area where the refrigerator is below 50 degrees F, you must either move the refrigerator to a heated are or build a cover for the refrigerator.
	Thermostat knob is at a cold setting	Turn thermostat knob counterclockwise to the warmest position, then turn it clockwise to setting "2"

Note:

1. Frost on evaporator tube will only occur when refrigerator has not been running for a period of time, or upon initial start-up.(first time refrigerator is lit)

Troubleshooting

Problem	Likely Cause	Solution
Burner will not light	Is the ignitor sparking?	Reconnect ignitor wire Inspect that the spark electrode tip is not further from the burner slots than 1/8" (3 MM) (see picture on page 10)
	Is the ignitor wire shorting out?	Inspect the ignitor wire for frays and tears, and if torn or frayed, call your local Diamond dealer for a replacement
	Is the ignitor functioning?	Operate the ignitor more often when lighting the refrigerator. Push the button rapidly until the flame lights
Ignitor sparks, but the burner will not light or stay lit	Is the thermocouple functioning?	If the flame does not stay lit when you release the gas safety button, replace the thermocouple.
	Is the gas pressure correct?	Have a qualified technician check your gas pressure. i.e. your local propane company. The gas pressure should be 11" W. C.

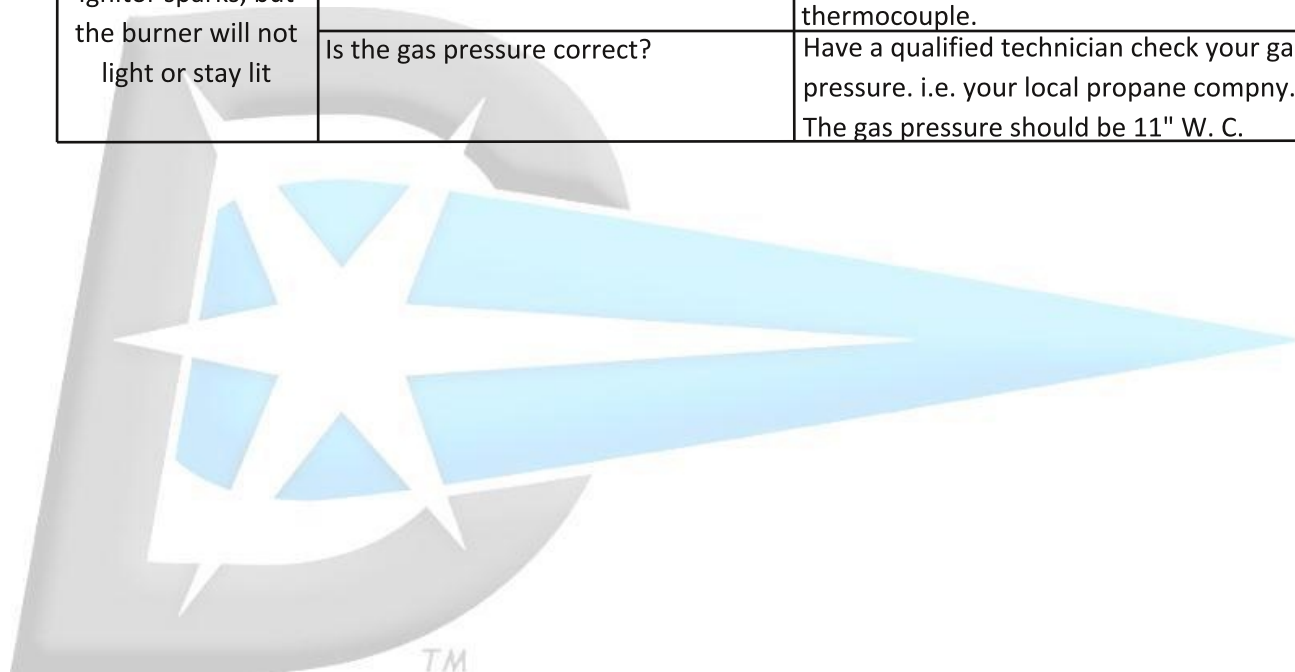

Gas Train Assembly Diagram

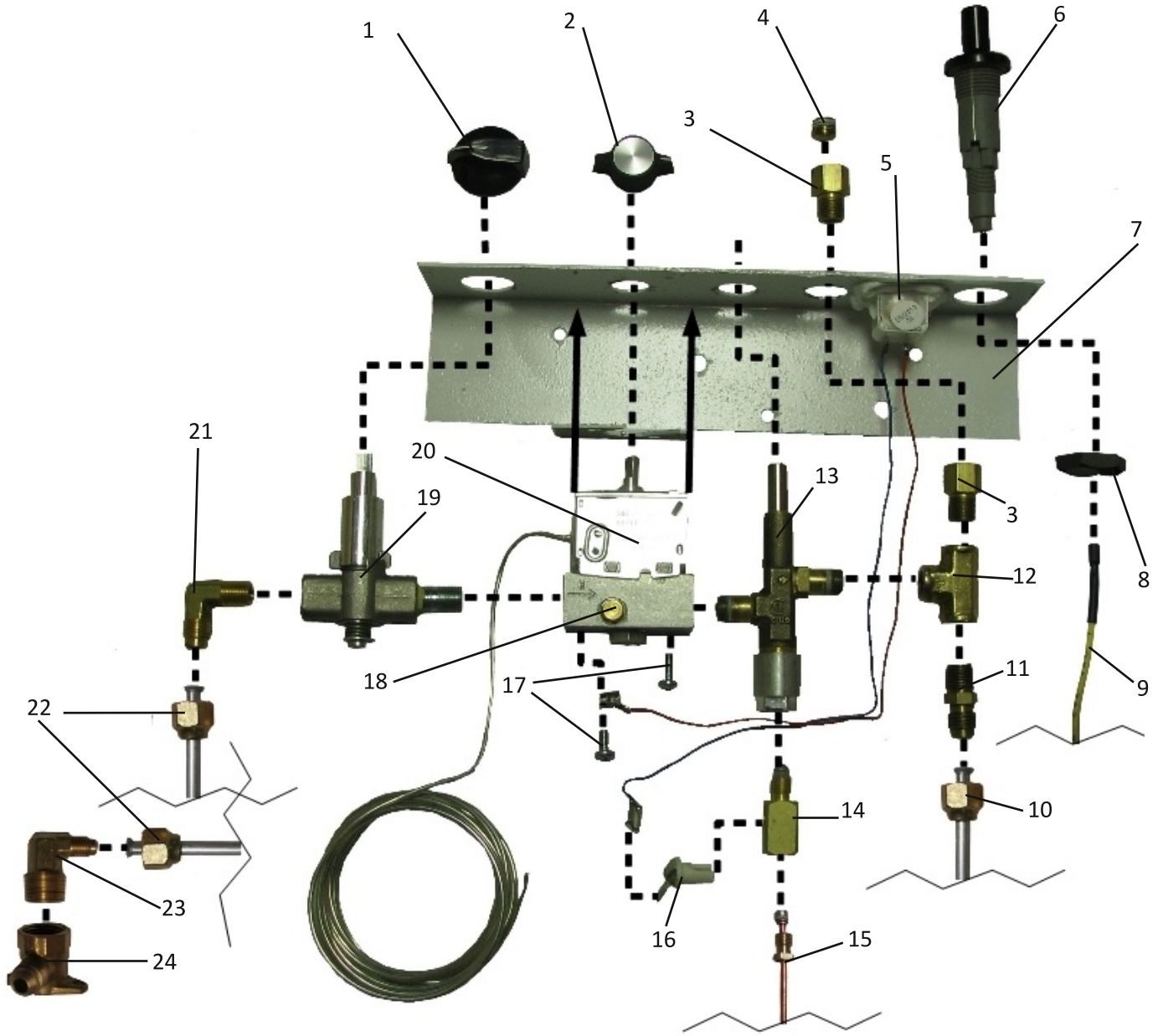

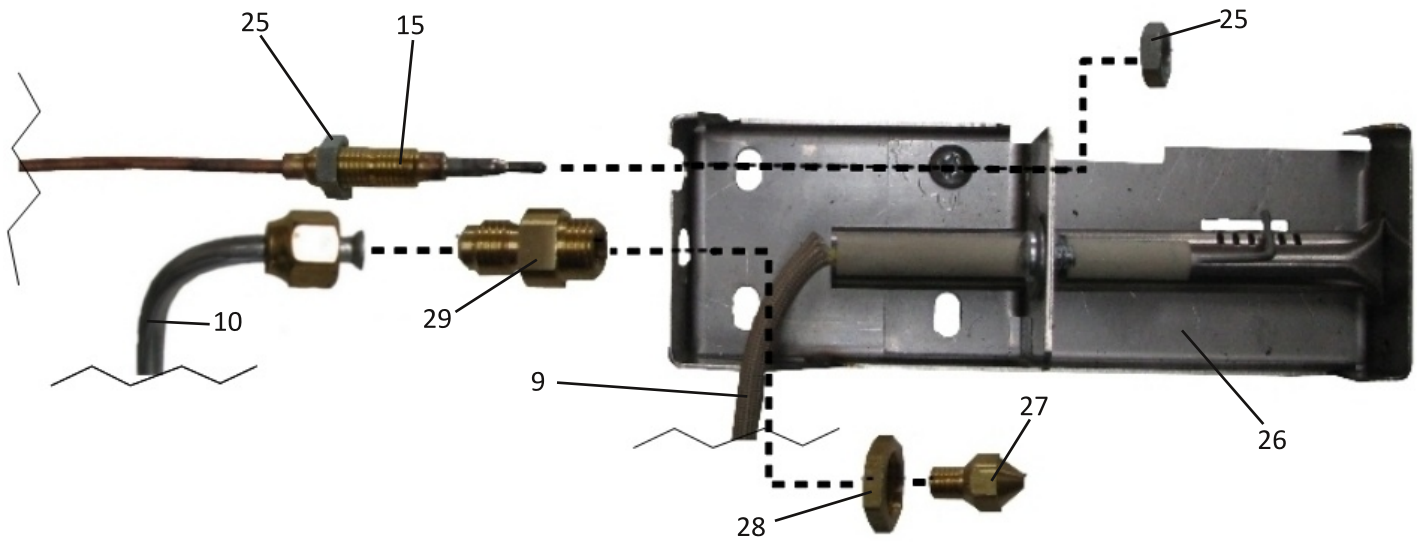

Callout Number	Description	Part Number
1	Gas Valve Knob	KNOB ON/OFF
2	Thermostat Knob	KNOB 06 00452 0
3	1/8" Straight Street	F 70
4	1/8" Plug	F72
5	Flame Meter with wires	FLAME
6	Piezo Ignitor	IGN
7	Thermostat Bracket	CONTLPLT-RAN
8	Piezo Ignitor Nut	IGN-NUT
9	Spark Electrode	ELECTRODE MSF
10	Burner Gas Line 1/4"	TUBING ALUM 1/4"x 37"
11	1/4" Flare x 1/8" MIP	F06
12	1/8" Brass tee	F71
13	Gas Safety Shut-off valve	GAS-SAF
14	Flame Meter Adapter	FLAME IND
15	Thermocouple	T-48", T STRD
16	Flame Meter Adapter Insert	FLAME IN INSERT
17	Screws	THERMOSTAT MNT SCREWS
18	Bypass Screw	BYPASS
19	1/8" Shut-off Valve	BA-7
20	Ranco Thermostat	THR
21	1/4" Flare x 1/8" MIP Elbow	F07
22	1/4" Inlet Gas Line	TUBING ALUM 1/4"x 45"
23	1/4" Flare x 1/2" MP Elbow	F05
24	3/8" Flare x 1/2" FIP Drop Ear	F26
25	Thermocouple Nut	T-48", T STRD NUT
26	Burner	BURNER
27	Orifice Spud	M14
28	Orifice Nut	M04
29	Orifice Body	M13

Elite (White Color)

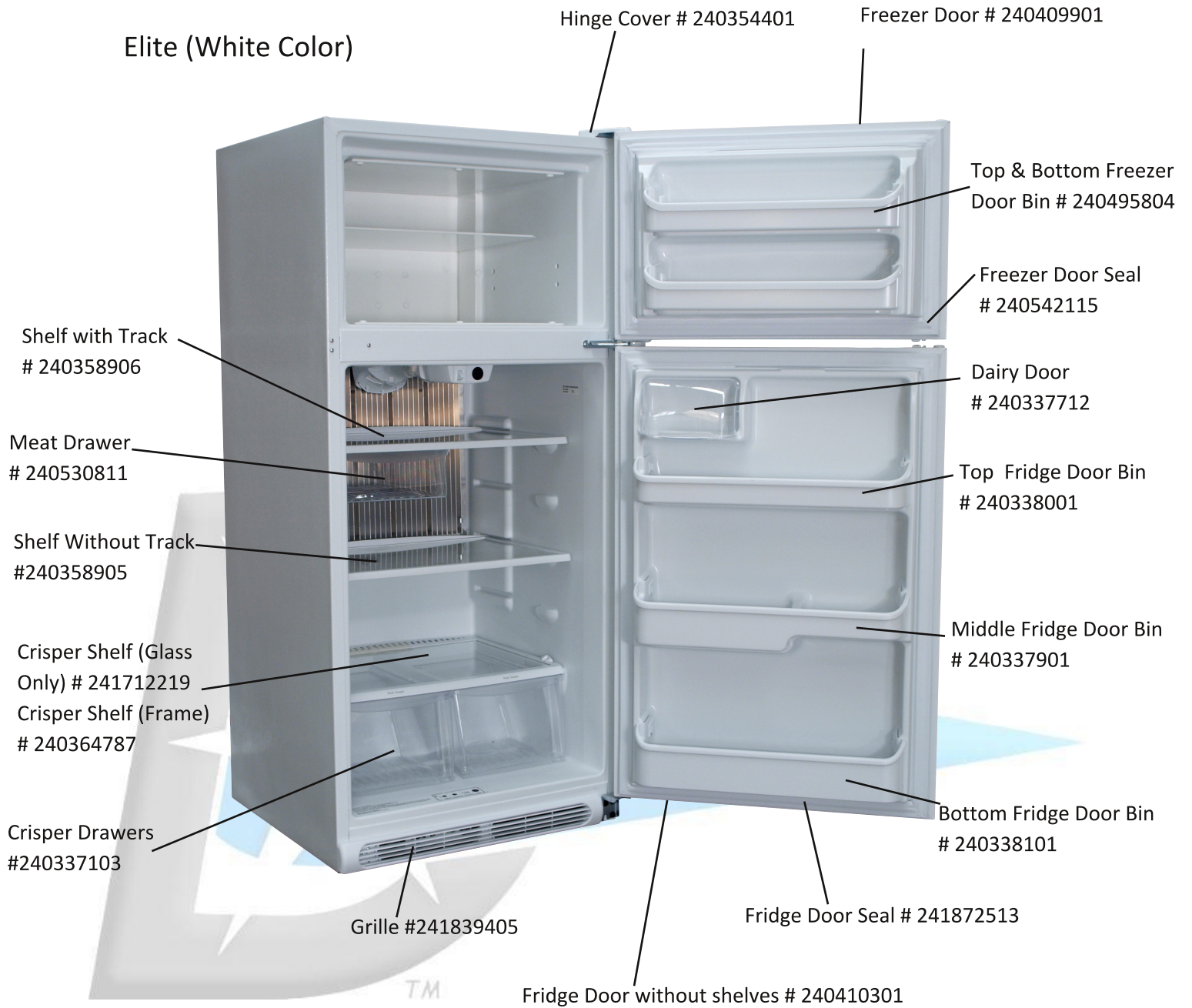

Elite (Bisque Color)

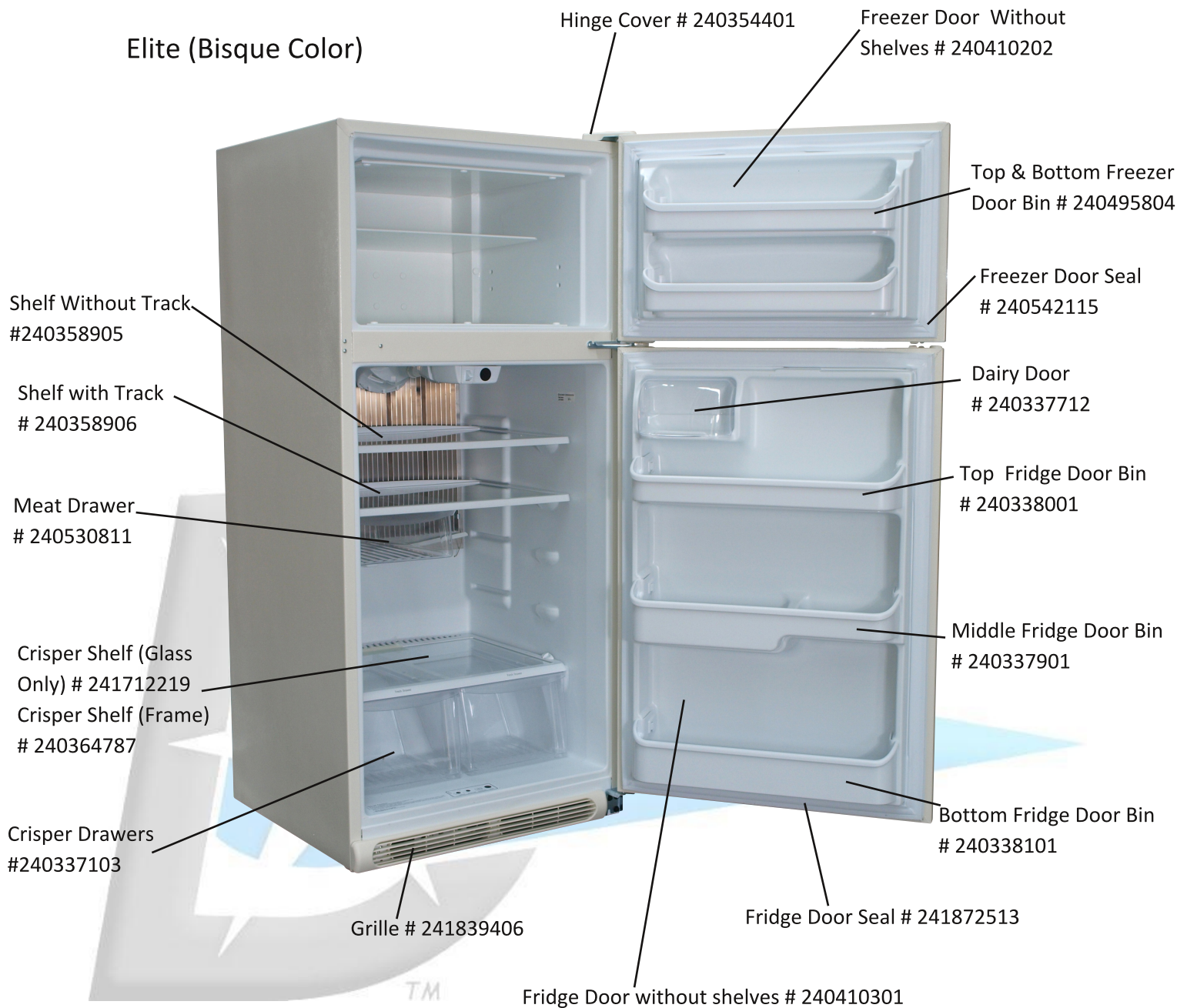

Elite (Black Color)



Elite (Stainless Steel Color)



DOOR REMOVAL INSTRUCTIONS

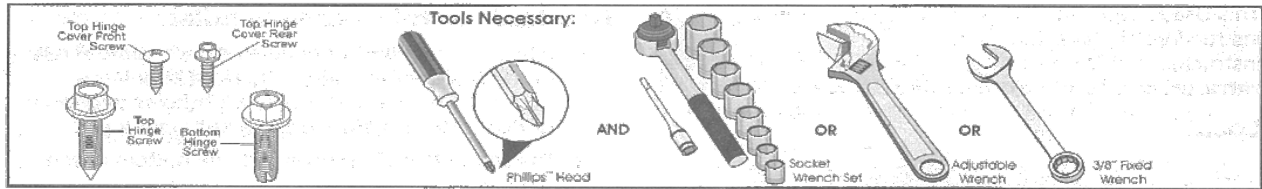

NOTE

The direction in which your refrigerator doors open (door swing) can be reversed, from left to right or right to left, by moving the door hinges from one side to the other. Reversing the door swing should be performed by a qualified person.

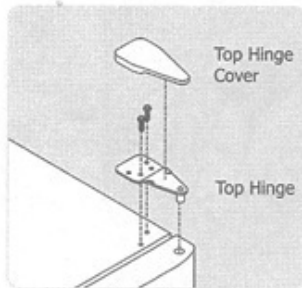

Door removal and reversal instructions:

- 1 Remove toe grille.
- 2 Remove top hinge cover. Trace around the hinge with a soft lead pencil. This makes reinstallation easier. Remove top hinge and lift door off center hinge pin. Set door aside.
- 3 Unscrew center hinge pin using adjustable wrench and save for reassembly. Ensure plastic washer stays on hinge pin.
- 4 Lift refrigerator door off of bottom hinge and set aside.
- 5 Remove center hinge and shim by removing inside screw and loosening two outside screws enough to allow hinge and shim to slide out. Tighten screws.
- 6 Loosen two outside screws on opposite side of refrigerator, remove inside screw and install center hinge.
- 7 Remove two screws on bottom hinge with 3/8" socket wrench.
- 8 Install bottom hinge on opposite side with the two screws removed from step 7.
- 9 Unscrew bottom hinge pin using adjustable wrench. Move hinge pin to other hole in hinge and tighten with adjustable wrench.
- 10 Reverse door handles (see instruction on next page).
- 11 Move freezer and refrigerator door stops to opposite side. Before starting screws, use an awl to puncture the foam.
- 12 Position refrigerator door onto bottom hinge pin and screw center hinge pin through center hinge into top of door. Close refrigerator door to help align hinge hole.
- 13 Tighten center hinge pin with adjustable wrench.
- 14 Remove cabinet and hinge hole plugs and move to opposite side.
- 15 Lower freezer door onto center hinge pin.
- 16 Close freezer door. Have an assistant lift up on opposite side of door while tightening screws to install top hinge.
- 17 Flip toe grille and reinstall.

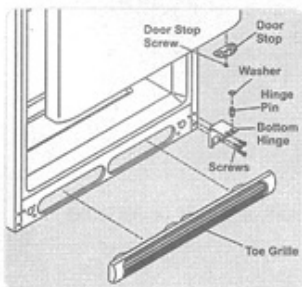
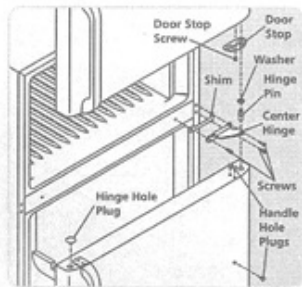

HANDLE INSTALLATION

To attach plastic refrigerator handle:

- 1 Place top of handle over dovetail screw, pull handle straight down until handle is aligned with screw holes on top of door.
- 2 Secure top of handle with two screws.

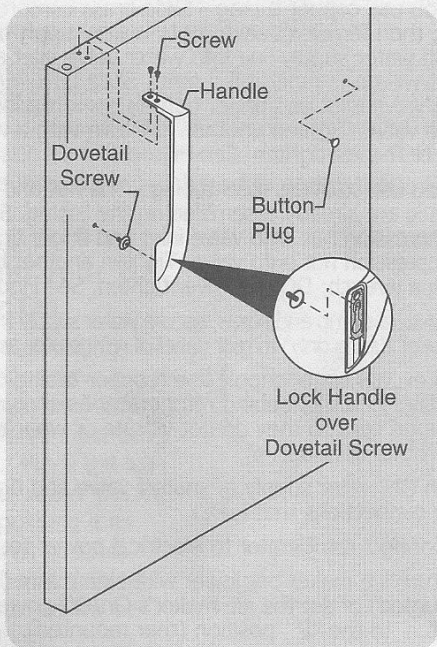

To attach plastic freezer handle:

- 1 Place top of handle over dovetail screw, pull handle straight up until handle is aligned with screw holes on bottom of door.
- 2 Secure bottom of handle with two screws.

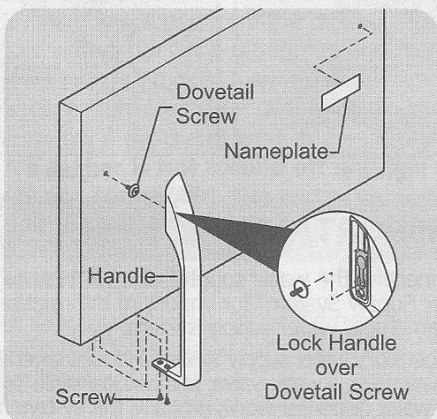

To reverse refrigerator/freezer handles:

Handles may be easier to reverse while doors are off. Reverse freezer and refrigerator handles as shown.

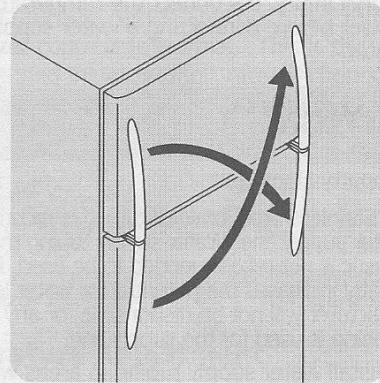

CAUTION

Be sure doors are set aside in a secure position where they cannot fall and cause personal injury.

